

3 Projection Hex Weld Nuts: HS3 1420

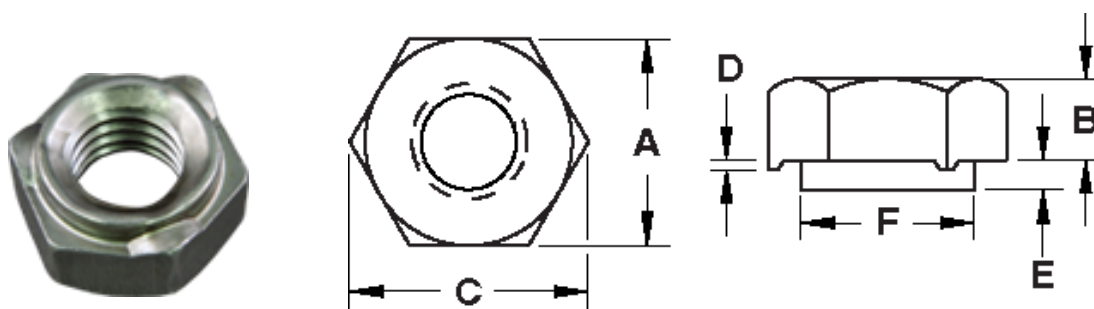

Thread Size	1/4-20
Width (in)	0.500
Thickness (in)	0.187
Pilot Height (in)	0.040
Pilot Diameter (in)	0.406
A (in)	0.500
Tol A (in)	+0.000 / -0.011
B (in)	0.187
Tol B (in)	+0.010 / -0.010
C Width Across Ref. Only (in)	0.556
D (in)	0.025
Tol D (in)	+0.003 / -0.003
E (in)	0.040
Tol E (in)	+0.005 / -0.005
F (in)	0.406
Tol F (in)	+0.000 / -0.012
Material	C1010 High-Welding Quality, Low Carbon Steel
Finish	Plain, Unless Specified
Threads	Unified Standard Class 2B ASME B 1.1-2003



DISTRIBUTED BY

ADVANCE 
COMPONENTS

advancecomponents.com

972-446-5500